

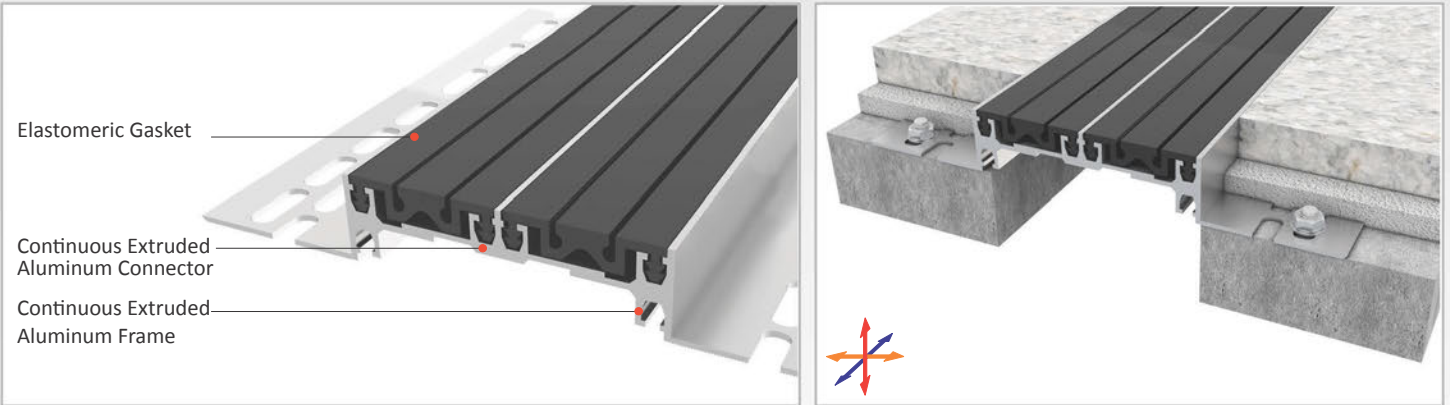

AS A246 flush mounted profile floor profiles for 20mm, 30 mm, 50 mm, and 100 mm gaps are applicable to all types of floors and individually designed for pedestrians, cars and forklifts. Push-down elastomeric gasket can be changed without demounting the profile. Smooth type gasket is available for all gaps but with less movement capability compared to grooved type. Profiles for 30 & 50 mm gaps are manufactured with single gasket while profile for 100 mm gap is with double gaskets joined with a connector profile. Punched base frame lets the profile to be installed in an easy, quick and secured way. Profile can be applied with wall type AS A146 and this dual application brings in a decorative aspect.

- Application Areas** : Indoor & Outdoor / Floor
- Ideal for** : Factories, Warehouses, Car Parks, Shopping Malls, Airports, Residences, Hospitals, Hotels, Public & Commercial Buildings etc.
- Material** : Mill Finish Aluminum (Anodizing optional), TPE Gasket
- Aluminum Alloy** : 6063 AA-USA / EN AW 6063
- Optional Supplies** : Fire Barrier, Waterproof EPDM membrane, Vapour Barrier



FLOOR

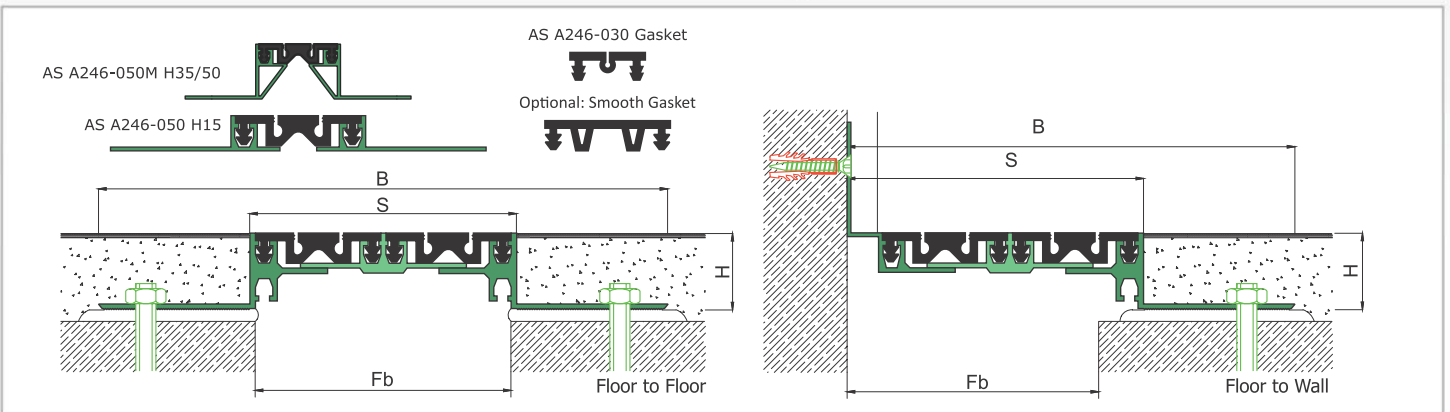

* Visuals are representative and the profile configuration may differ depending on the characteristics requested.



LOCATION	MODEL	GAP (Fb) mm	HEIGHT (H) MM	OVERALL WIDTH (B) mm	VISIBLE WIDTH (S) mm	MOVEMENT (W) mm	LOAD CAPACITY	STANDARD LENGTH (mt)
Floor to Floor	AS A246-020	20	26	120	24	± 4		3
	AS A246-030	30	15	130	34	± 5		3
	AS A246-030	30	26	154	34	± 5	25 kN	3
	AS A246-030	30	35 / 50	126 / 130	34	± 5	25 kN	3
	AS A246-050	50	15	150	54	± 7		3
	AS A246-050	50	26	174	54	± 7		3
	AS A246-050	50	50	144 / 162	54	± 7		3
	AS A246-050M	50	35 / 50	144 / 152	54	± 7		3
	AS A246-050	50	80	148	54	± 7		3
	AS A246-100	100	30	226	106	± 14		3
	AS A246-100	100	45 / 80	200 / 210	105	± 14		3

Note: Please ask for different sizes

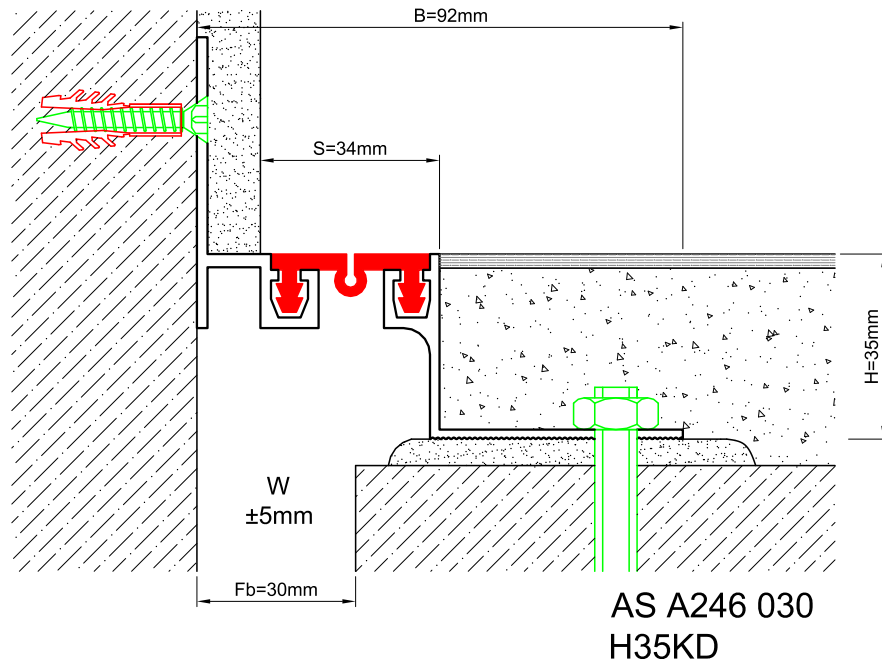
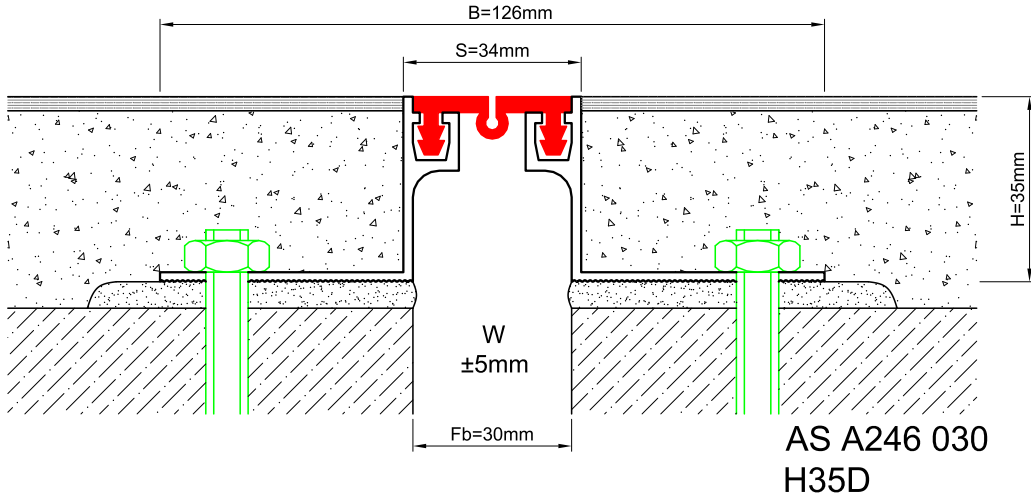

Profil No Profile Number	AS A246 030	AS A246 030K
Fb (mm)	30	30
H (mm) yaklaşık approx.	35	35
W± (mm) yaklaşık approx.	±5	±5
Renk Color	Alüminyum: Natürel, Fitiller: Siyah, gri, diğer Aluminum: Natural, Inserts: Black, grey, others	
Malzeme Material	Alüminyum, TPE Termoplastik Elastomer Aluminum, TPE Thermoplastic Elastomer	
Standart Uzunluk Standard Length	3	
Yükleme Kapasitesi Load-Bearing Capacity	25kN 